

Hand Rails

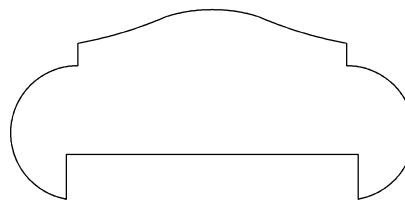

WH-487-HR

$1\frac{1}{2}'' \times 3''$



WH-851-HR

$1\frac{1}{16}'' \times 2\frac{1}{4}''$



WH-356-HR

$2\frac{1}{4}'' \times 5''$

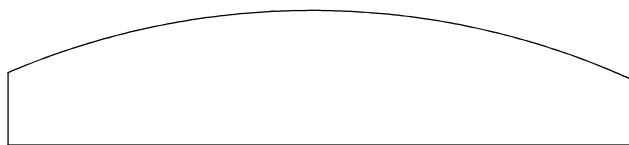

WH-466-H4 $\frac{3}{4}'' \times 3\frac{1}{2}''$



WH-438-HR

$1\frac{3}{4}'' \times 5\frac{1}{2}''$

Hand Rails

WH-704-HR

$1\frac{3}{8}" \times 3\frac{1}{4}"$

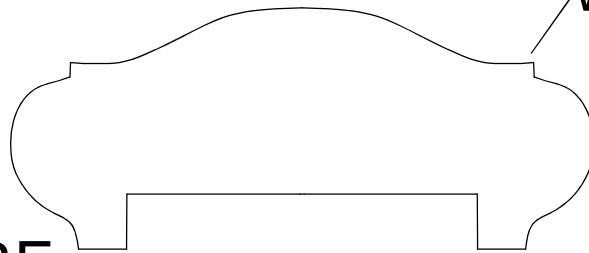

$1\frac{1}{2}"$ SQUARE
BALLUSTERS
GO HERE

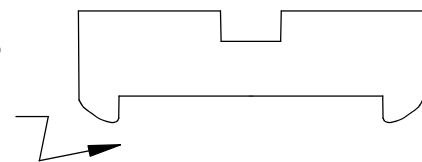

WH-705-HR

$\frac{5}{8}" \times 1\frac{15}{16}"$

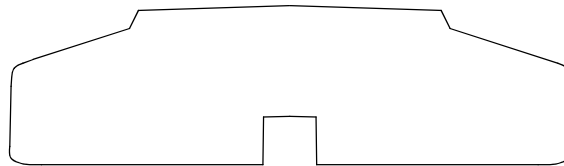

WH-706-HR-SHOE

$\frac{7}{8}" \times 3\frac{1}{8}"$

SH-11-HR

$2\frac{1}{4}" \times 2\frac{7}{16}"$

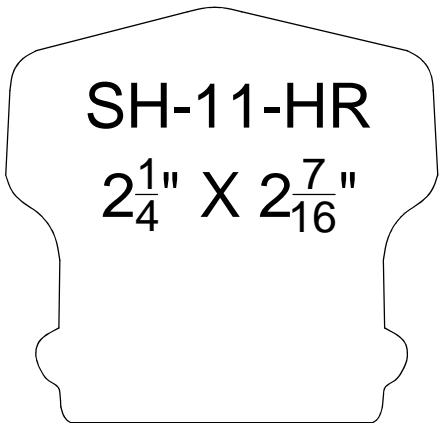

WH - 925 - HR

$2" \times 2\frac{3}{4}"$



RB-101-HR

$2\frac{3}{8}" \times 2\frac{7}{8}"$

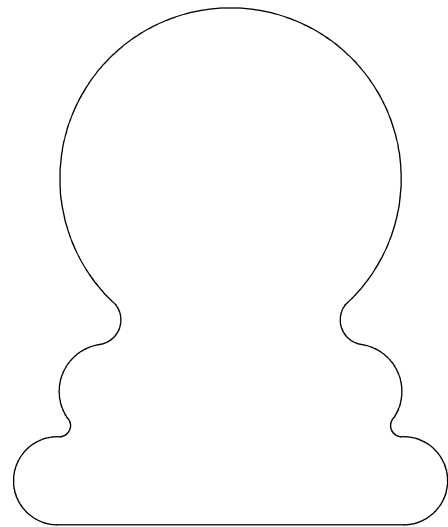

Hand Rails

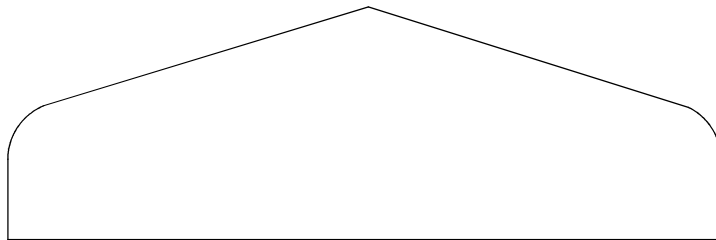
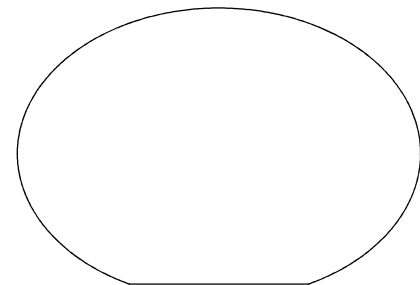
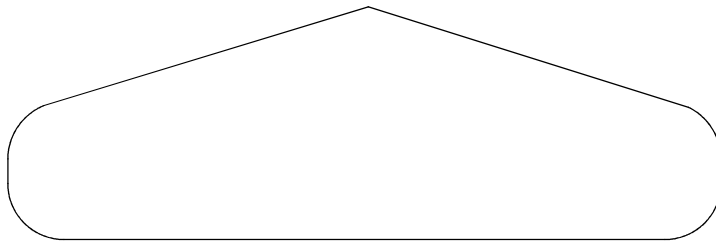
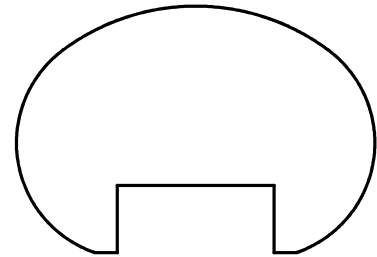
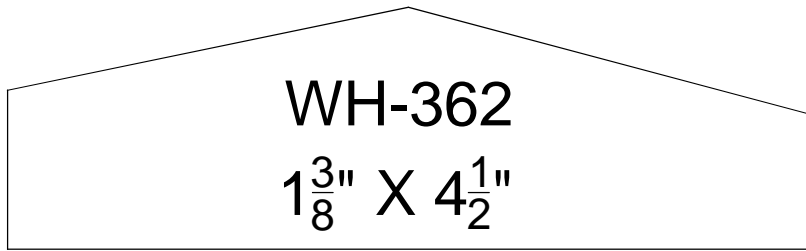

WH-327-HR-SHOE

$1\frac{1}{4}$ " X 4"

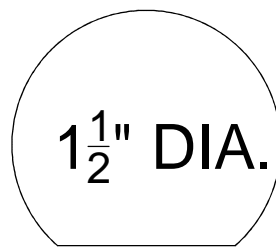

1" DIA.

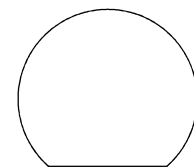

Virtually any size round rail profile available.

Hand Rails

WH-267-HR-HAND

$1\frac{7}{16}$ " X $5\frac{1}{2}$ "

WH-267-HR-SHOE

$1\frac{1}{2}$ " X $5\frac{1}{2}$ "

WH-269-HR

$1\frac{1}{8}$ " X $5\frac{1}{2}$ "

WH-229-HR

$1\frac{7}{8}$ " X 4"

Hand Rails

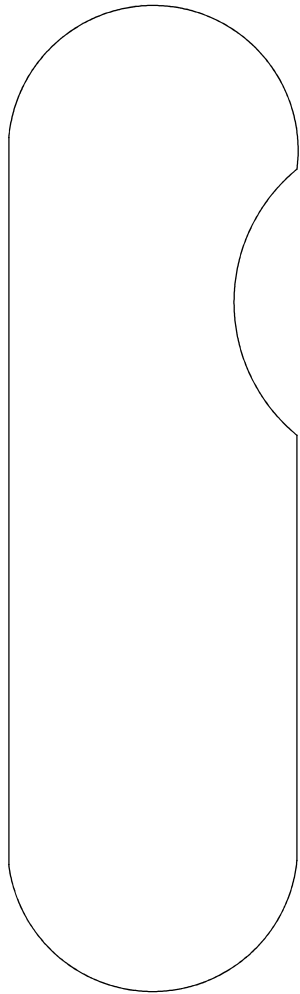

WH-511-HR

$1\frac{5}{8} \times 5\frac{1}{2}$ "

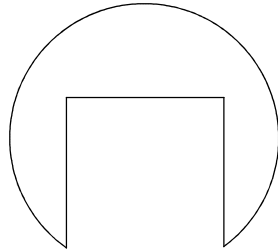

WH-359-HR

$1\frac{3}{8} \times 1\frac{1}{2}$ "

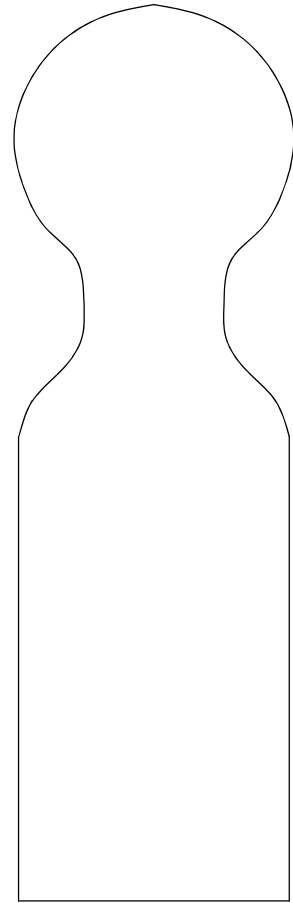

WH-373-HR

$1\frac{1}{2} \times 5$ "

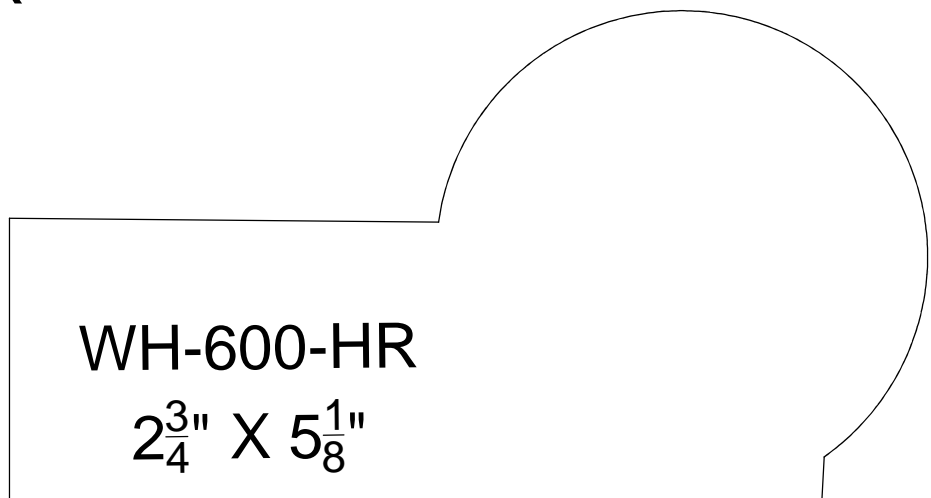

WH-600-HR

$2\frac{3}{4} \times 5\frac{1}{8}$ "

Hand Rails

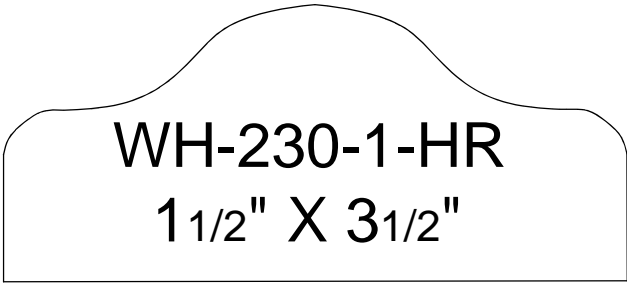

WH-230-1-HR
1 1/2" X 3 1/2"

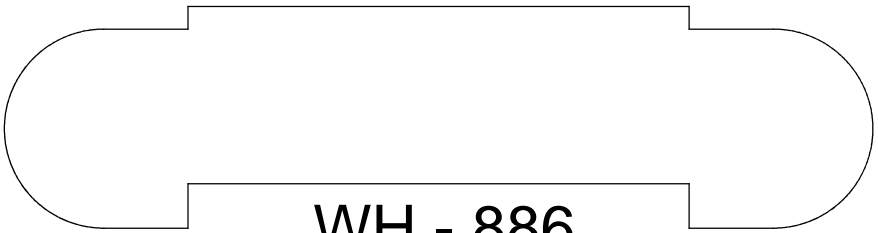

WH - 886
1 1/4" X 4 7/8"



WH - 929 - HR
4" X 3 1/2"

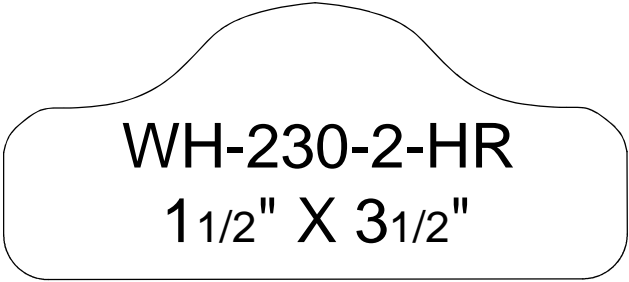

WH-230-2-HR
1 1/2" X 3 1/2"