

TM-1130
5 1/4" FACE

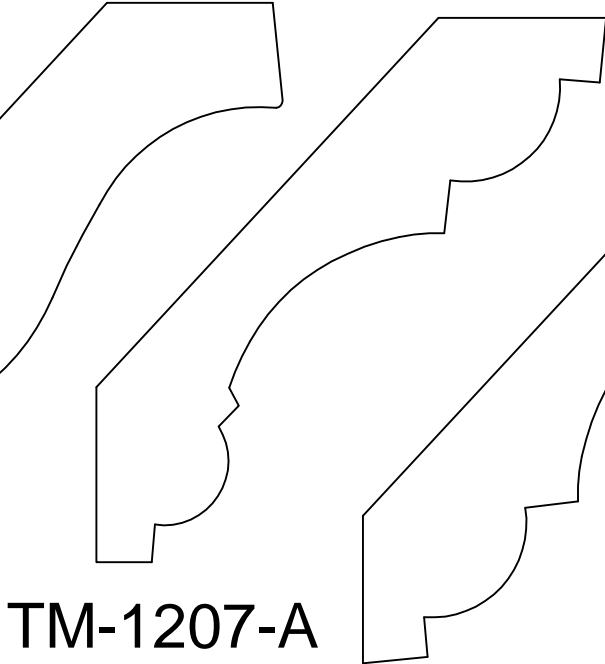

TM-1207-A
4 3/16" FACE

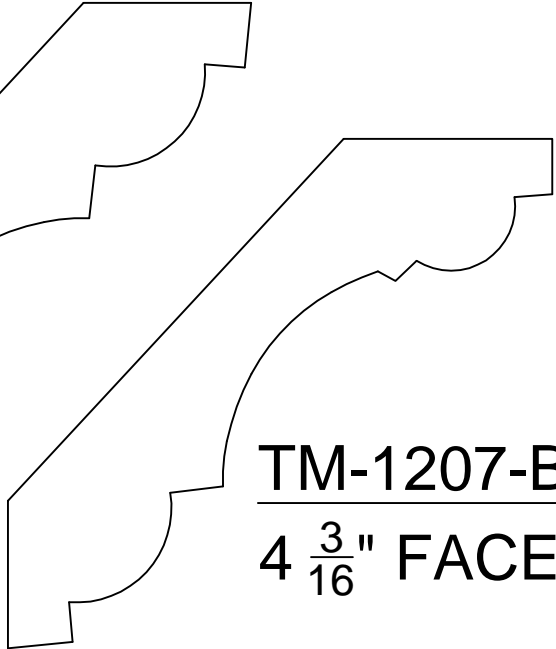

TM-1207-B
4 3/16" FACE

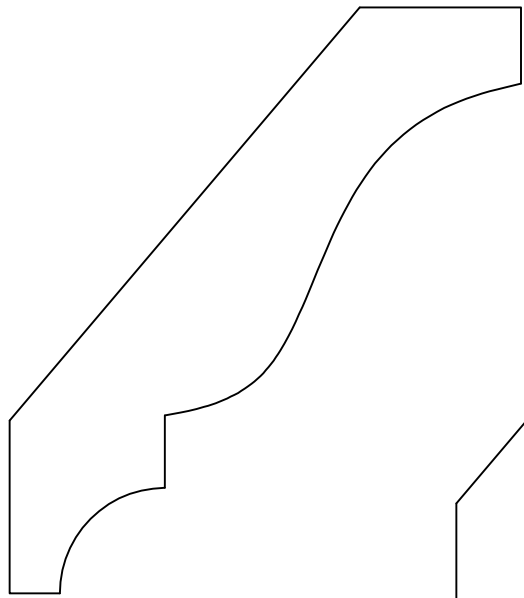

TM-1005
4 5/16" FACE

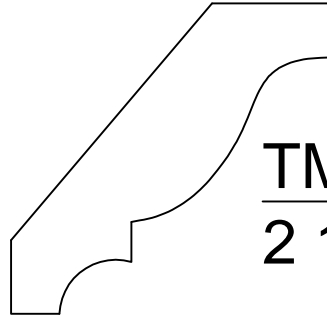

TM-1022
2 1/2" FACE

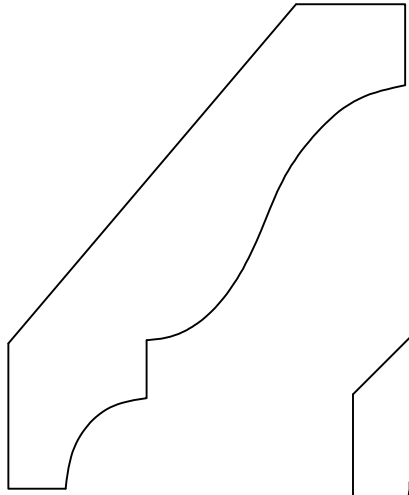

TM-1004
3 1/2" FACE

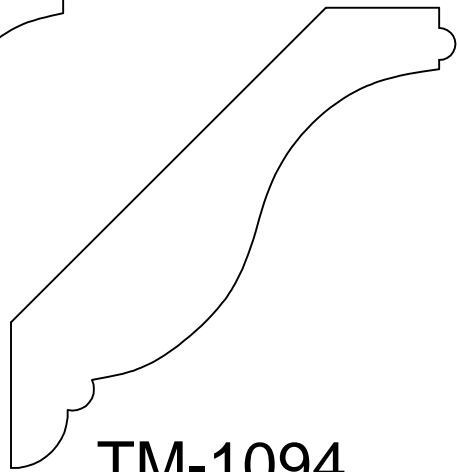

TM-1094
3 1/2" FACE

TM-1012
8 1/2" FACE

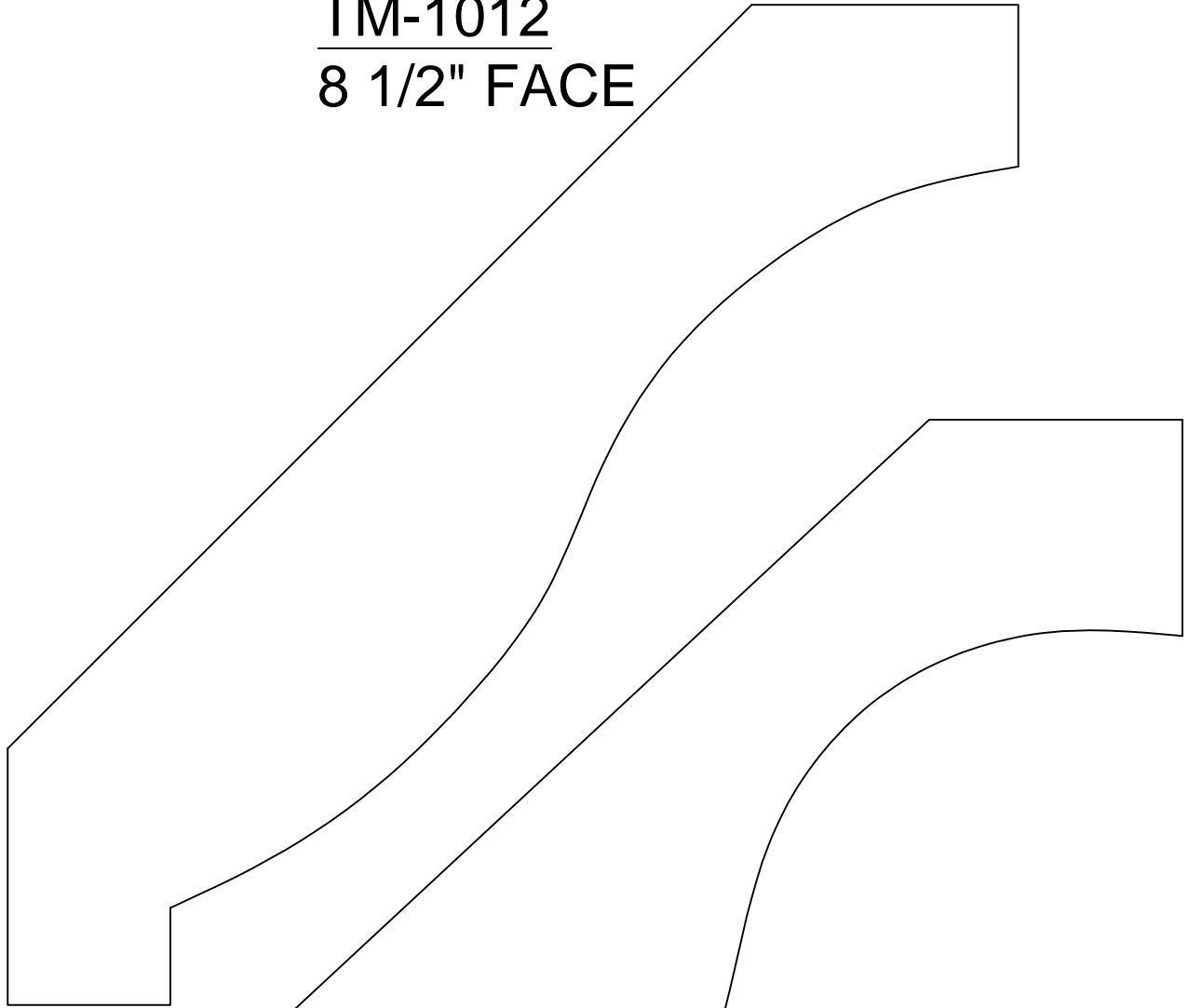

TM-1003
9 1/2" FACE

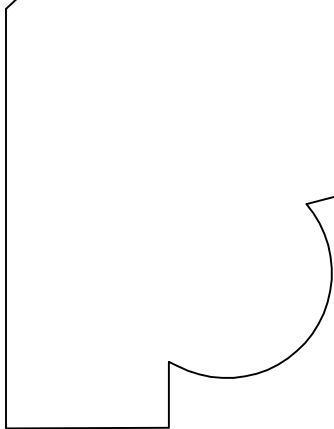

TM-1141
5 1/4" FACE

TM-1140
6" FACE

TM-1009
2 1/4" FACE

TM-1161M
1 7/8" FACE

TM-1161
2 1/2" FACE

TM-1059
5 3/4" FACE

TM-1131
4 3/8" FACE

TM-1188

7 $\frac{13}{16}$ " FACE

TM-1073

6 $\frac{15}{16}$ " FACE

TM-1053

5 $\frac{1}{4}$ " FACE

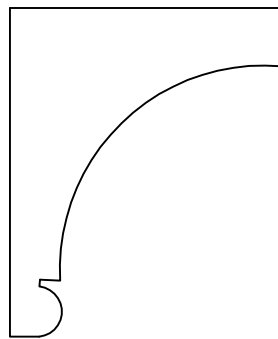

TM-1171

2 $\frac{3}{8}$ " FACE

TM-1132

3 $\frac{7}{16}$ " FACE

← 10 $\frac{5}{8}$ →

DRAWING NOT TO SCALE

TM-1190
15" FACE

↑ 10 $\frac{5}{8}$ ↓

15

TM-1136
4 $\frac{13}{16}$ " FACE

TM-1079
2 $\frac{1}{8}$ " FACE

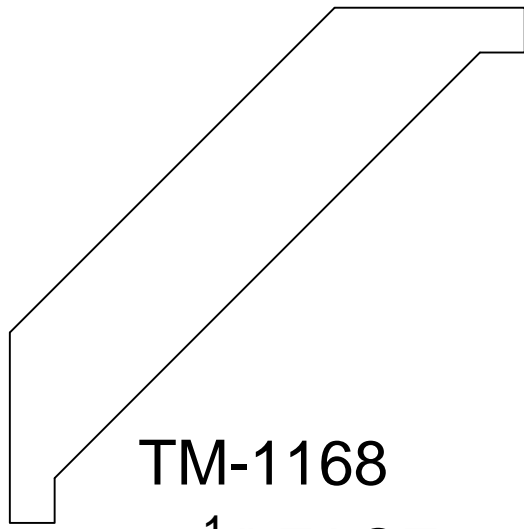

TM-1168
4 $\frac{1}{16}$ " FACE

